

Conector industrial multipin 6 -pini (35A)

Tip/Type CIM 6

Carcasa

- 6x35A (6P+E)
- Grad de protectie IP 65
- 400-690V / 50-60 Hz
- Inel de fixare (presetupa):
PG 16

Hood

- 6x35A (6P+E)
- Degree of protection IP 65
- 400-690V / 50-60 Hz
- Fixing ring:
PG 16

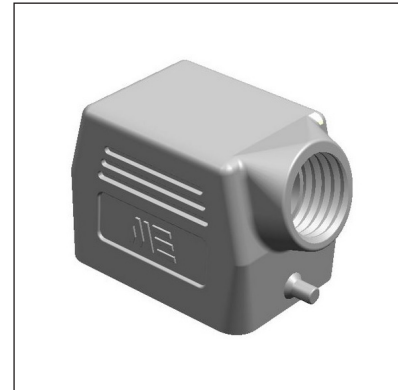

Tip/Type SIM 6

Soclu

- 6x35A (6P+E)
- Grad de protectie IP 65
- 400-690V / 50-60 Hz

Plug

- 6x35A (6P+E)
- Degree of protection IP 65
- 400-690V / 50-60 Hz

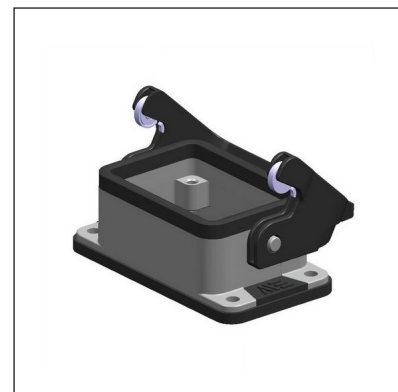

Tip/Type IT 6-35

Insertie tata

- 6x35A (6P+E)
- Grad de protectie IP 65
- 400-690V / 50-60 Hz

Male insert

- 6x35A (6P+E)
- Grad de protectie IP 65
- 400-690V / 50-60 Hz

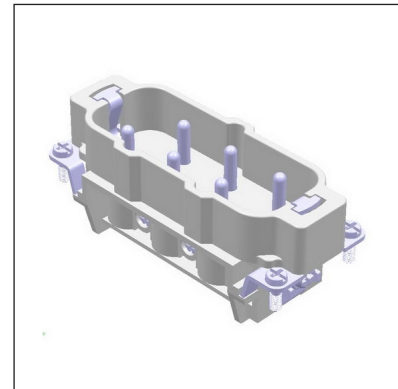

Tip/Type IM 6-35

Insertie mama

- 6x35A (6P+E)
- Grad de protectie IP 65
- 400-690V / 50-60 Hz

Female insert

- 6x35A (6P+E)
- Grad de protectie IP 65
- 400-690V / 50-60 Hz

